

NEW:
*bigger capacity,
 maximised protection*
 The NEW DataPlus+ range from Chubb safes has been expertly designed to ensure you have the best protection for your vital data media now with extra capacity.



DataPlus+

fire resistant data protection

Key features

- Easy slam action emergency closing in event of a fire.
- Generous capacity. Chubb safes cabinets have been designed to give you more for your money than most other manufacturers' cabinets.
- Quality media protection.
- 2 hour datamedia protection label. Tested to the highest international standards; UL 72 and EN 1047-1. CEN Norm is certified by ECB.S in class S 120 DIS.
- Easy to transport and install. Low weight ratio due to new advanced fire protection barrier material.
- Ability to customise by using internal fittings to optimise your storage capacity.
- Removable front plate allows usage of a pallet loader for a more efficient installation, additionally allowing a cost advantage to the customer.
- Ability to base fix to the floor for an effective prevention of physical removal.
- The cabinet is fitted with a keylock as a standard. However, you may require the monitoring of access to your sensitive data and therefore we have a series of electronic locks ranging from basic locking to more sophisticated audit trails.
- The cabinet is an attractive light grey which fits in well in most office interiors.



Chubb safes
 Trusted the world over.

DATA
 PROTECTION

Capacity Chart

New FRE DATA platform
 Version: Compact storage

Media designation	Size f Dimension g (in mm)	Per shelf (level)		Storage	Model									
		Size 1-4	Size 5		Size 1		Size 2		Size 3		Size 4		Size 5	
					no of shelves	total capacity	no of shelves	total capacity	no of shelves	total capacity	no of shelves	total capacity	no of shelves	total capacity
Magnetic discs:														
DLT - tapes	110 x 112 x 30	48	94	F + L	4	192	7	336	9	432	13	624	13	1222
LTO tapes	110 x 112 x 30	48	94	F + L	4	192	7	336	9	432	13	624	13	1222
DDS 4 mm (DC 4)	80 x 58 x 16	124	239	F + L	8	992	12	1488	16	1984	22	2728	22	5258
DDS 8 mm (DC 8)	102 x 68 x 20	79	148	F + L	7	553	10	790	14	1106	19	1501	19	2812
DAT Cassettes	80 x 60 x 15	134	260	F + L	8	1072	12	1608	16	2144	22	2948	22	5720
Data Cartridges 3,5"	96 x 100 x 12	144	274	F + L	5	720	7	1008	10	1440	14	2016	14	3836
Data Cartridges 5,25"	141 x 159 x 17	69	130	F	3	207	4	276	6	414	9	621	9	1170
AIT Data Cartridge (Sony)	67 x 112 x 21	108	216	F + L	4	432	7	756	9	972	13	1404	13	2808
Travan Data Cartridge (Sony)	78 x 100 x 19	100	212	F	5	500	7	700	10	1000	14	1400	14	2968
On Stream ADR (Verbatim)	129 x 95 x 15	89	162	F + L	5	445	7	623	10	890	14	1246	14	2268
SLR / MLR 5,25" (Imation)	116 x 161 x 21	54	126	F + L	3	162	4	216	6	324	9	486	9	1134
PD Cartridge (Fuji)	135 x 124 x 8	153	227	F + L	4	612	6	918	8	1224	12	1836	12	2724
IBM 3480 / 3490	127 x 110 x 25	51	99	F + L	4	204	7	357	9	459	13	663	13	1287
Optical and Magnetic discs:														
CD / DVD (R, RW and RAM)	142 x 124 x 10	117	225	F	4	468	6	702	8	936	12	1404	12	2700
Diskette 3 1/2 (Floppy Disc)	94 x 90 x 3,0	596	1124	F + L	5	2980	8	4768	11	6556	15	8940	15	16860
Optical Disc 3,5	94 x 90 x 6	296	560	F + L	5	1480	8	2368	11	3256	15	4440	15	8400
Optical Disc 5,25	135 x 153 x 11	112	214	F + L	3	336	5	560	6	672	9	1008	9	1926
ZIP Disk Media	103 x 104 x 12	135	256	F + L	5	675	7	945	10	1350	14	1890	14	3584
MO - R/W (Magneto Optical Disk)	157 x 143 x 16	62	122	F + L	3	186	5	310	7	434	10	620	10	1220

F = frontal loading F + L = frontal and lateral loading

Internal Fittings

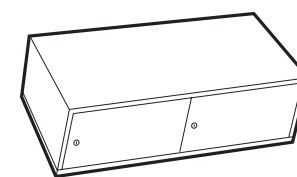

Lockable cupboard (size 5)

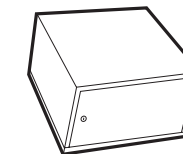

Lockable cupboard

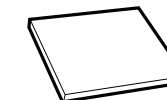

Adjustable shelf

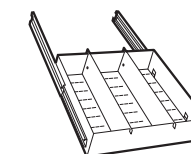

Pull out platform
(with dividers)

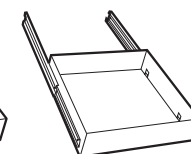

Pull out platform

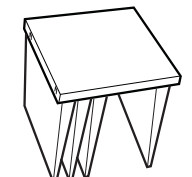

Suspended pocket shelf

Authorised dealer:

Chubb safes
 Trusted the world over.

PO Box 61, Wednesfield Road, Wolverhampton, WV10 0EW United Kingdom
 Tel. +44 (0) 1902 455111 Fax: +44 (0) 1902 351961
 Email: marketing@chubbsafesuk.com
 Website: www.chubbsafes.com

*Chubb is owned by Chubb plc and is a registered trademark used under license

Product specifications

Model	External dimensions (mm)			Internal dimensions (mm)			Internal Vol (litres)	Weight* (kg)	Fittings			
	Height	Width	Depth	Height	Width	Depth			Adjustable shelf	Pullout platform	Suspended pocket shelf	Lockable cupboard
Size 1	911	746	778	565	490	400	111	315	•	•	•	•
Size 2	1191	746	778	845	490	400	167	390	•	•	•	•
Size 3	1471	746	778	1125	490	400	221	490	•	•	•	•
Size 4	1941	746	778	1595	490	400	313	640	•	•	•	•
Size 5	1941	1036	830	1570	780	450	556	860	•	•	•	**

* Weight refers to an empty cabinet

** A double cupboard is only available in size 5

*** External depth is gross measurement incl. 60mm for handle which can be removed for installation

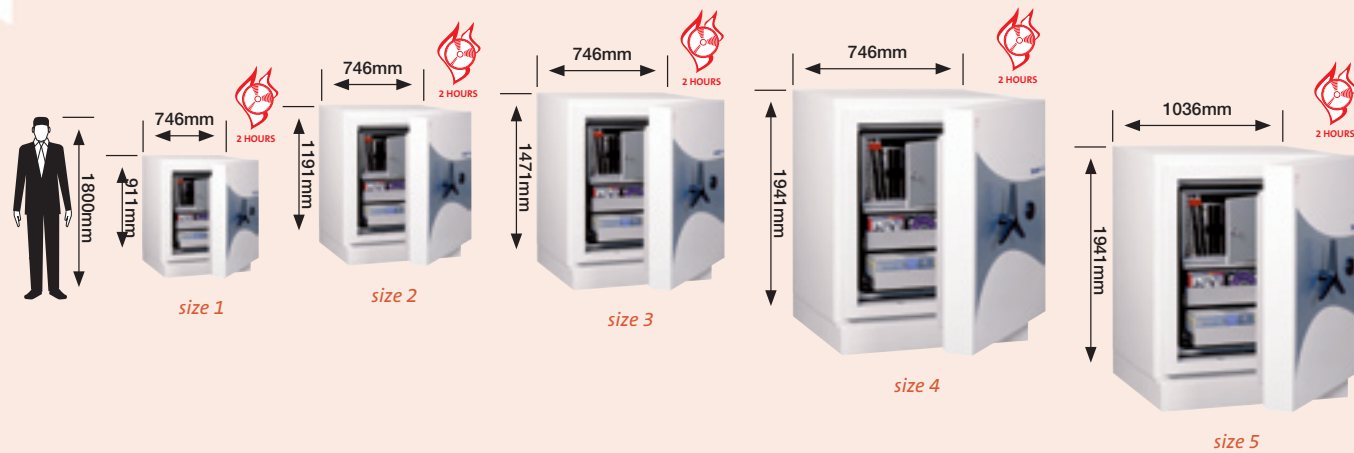

Installation Guide

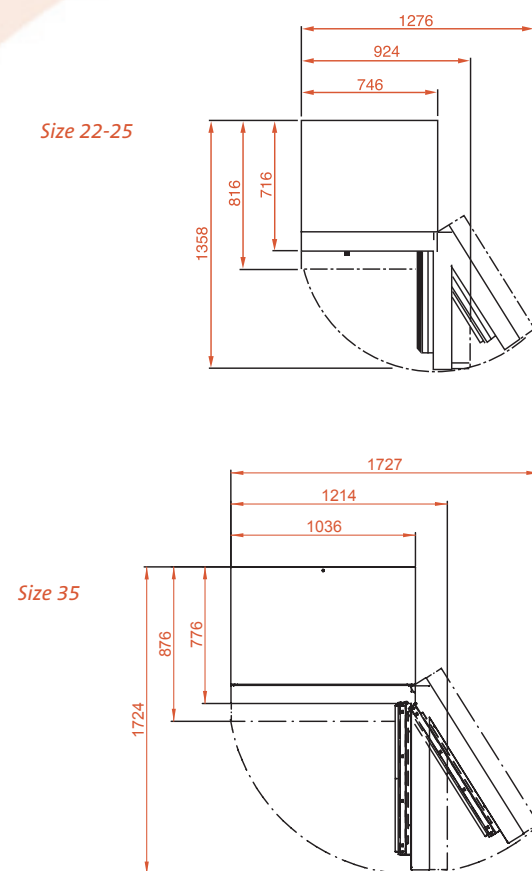

Locking Options



Testing

Part 1: EN 1047-1, UL- 72 and NT 017 FIRE tests.

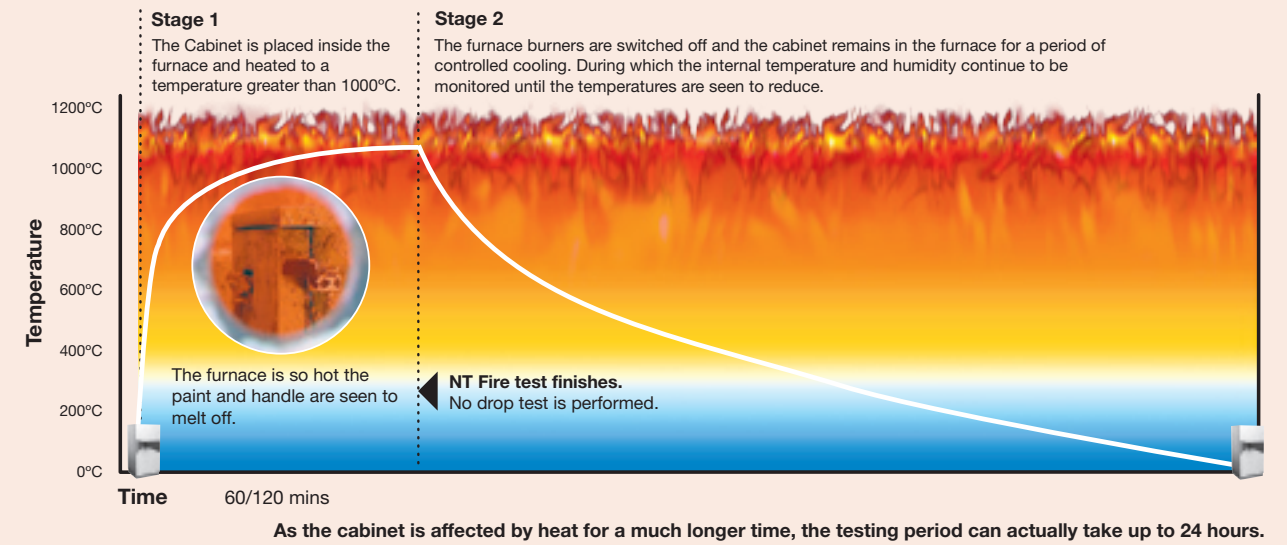

Part 2: EN 1047-1, UL-72

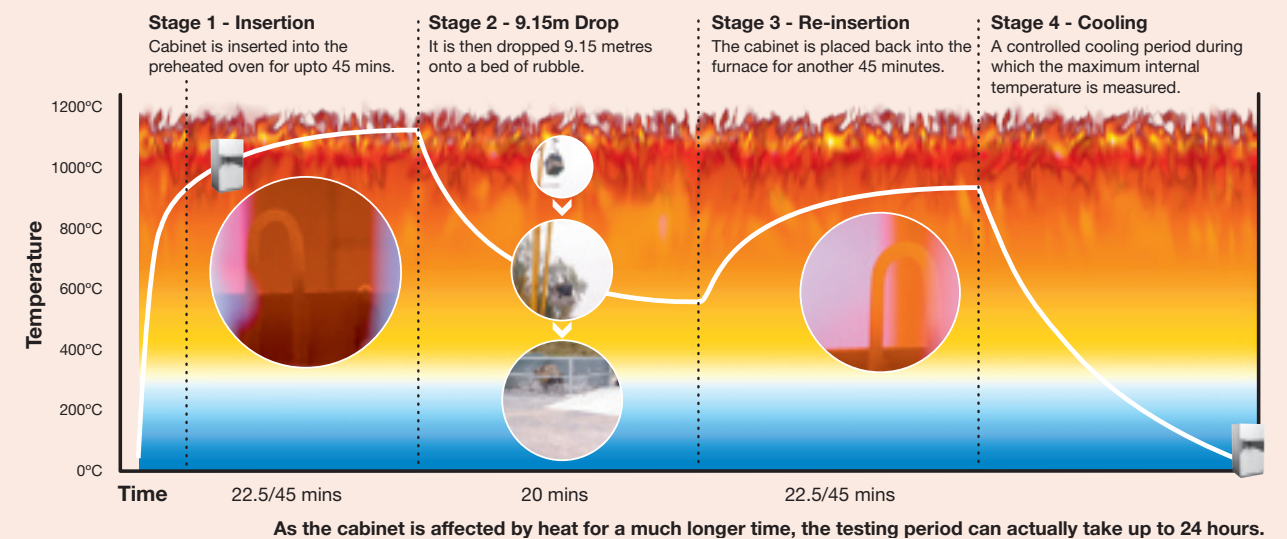

Consequences of a fire

Below illustrates the devastation caused after a fire. Imagine what would be left of your vital data media if it were not stored in a Chubb Safes' cabinet.

